

LinearColor Flex 8/400

Product specification sheet

With its sleek shape and completely homogenous and diffuse luminous output, the LinearColor Flex 8 is the right choice for direct lighting in design-sensitive installations. Because of its design, it is highly flexible along its horizontal axis, while also enabling vertical radii in excess of 1000 mm.

Let's design our future.

Döllken
Lighting

.....
we create.
we innovate.

SURTECO GROUP

dimensions

measures	8 x 14 mm
step length	50 mm
pitch	not visible
max. connection length	13 m

light

CCT of PCB*	2.7/3/4/5.000 K
luminous flux**	170 lm/m
binning	MacAdam Step 4
CRI of PCB [Ra]	> 90, (5.000K > 80)
expected life time	50.000 h, LM70

electrical

voltage	24 V
power	9,6 W/m
LEDs per step	5
current per step	20 mA
constant current driver	yes
each step	
ESD protection	yes
inverse polarity connection	yes
Tc°	45°C
dimmable	yes, only PWM
needed driver must comply	24 V DC SELV

mechanical

dimensions of smallest operating unit	50 x 8 x 14 mm
suitable mounting method***	aluminum mounting profile, glue
degree of protection (strip)	IP68, 10 m
degree of protection (connection)	IP68, 10 m
mechanical impact protection	IK10
bending radius vertical	1000 mm
bending radius horizontal	200 mm
aluminium profil dimensions	2.000 x 15,5 x 11 mm
aluminium profil colour	aluminium

encapsulation

combustibility class	UL-94-HB
dielectric strength	18 kV/mm
halogen free	yes
chlorine free	yes

environmental /compliances

ambient temperature	-20 °C to +60 °C
WEEE-Reg. No.	41380720, Döllken Lighting Flex Line
compliances	CE, RoHS, DIN EN 62031:2008, DIN EN 62717
warranty	5 years (conditions apply)
energy efficiency class	A - A++

light intensity distribution

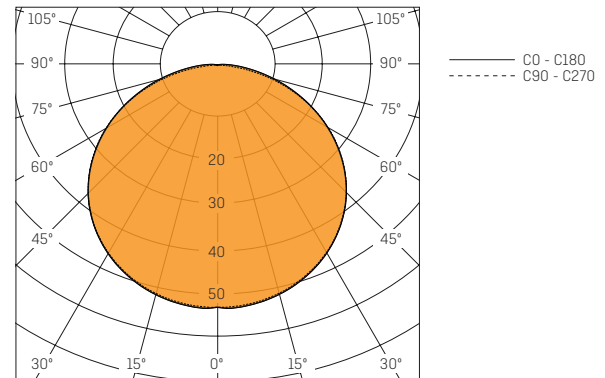

technical drawings

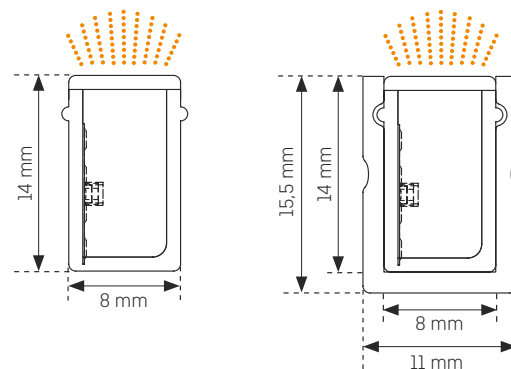

step schematic

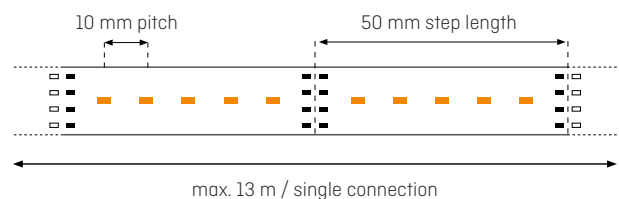

* correlated colour temperature of PCB, encapsulation will affect the colour temperature

** luminous flux is related to 5.000 K, warmer colour temperatures will reduce the luminous flux, all data are showing typical values, actual lumen output can be less and depends also on surface colour

*** the LED modules are being delivered without any adhesive tape or glue, aluminum profiles have to be ordered separately, recommendations regarding suitable glue/tapes are being given for individual projects

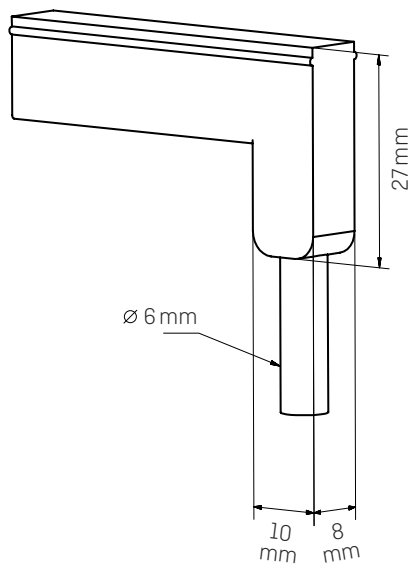

VERTICAL CONNECTION

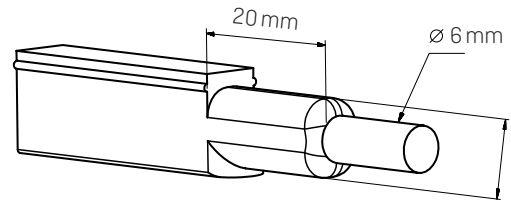

HORIZONTAL CONNECTION

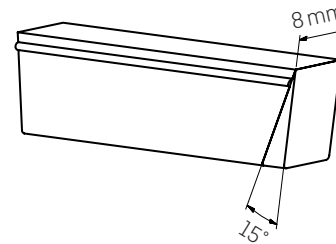

SQUARE ENDCAPS

Product	short form	CCT	article number
LinearColor Flex 8/400/2K7 white/opal	LCF 8/400/2K7 wh/op	2.700 K	5112580
LinearColor Flex 8/400/3K white/opal	LCF 8/400/3K wh/op	3.000 K	5112581
LinearColor Flex 8/400/4K white/opal	LCF 8/400/4K wh/op	4.000 K	5112582
LinearColor Flex 8/400/5K white/opal	LCF 8/400/5K wh/op	5.000 K	5112584
Aluminum Profile LCF8 small	-	-	5902840